

STOREFRONT SERIES B450XT

Air Infiltration: (ASTM E283-04)	0.06 cfm/ft at 6.24 psf
Water Resistance: (ASTM E331-09) (ASTM E547-09)	No Leakage at 12 psf
Uniform Load Deflection: (ASTM E330-10)	20 psf
Thermal Break:	Yes
Main Frame Depth:	4 1/2"
Glazing Thickness:	1"

Let's Shine.

B450XT STOREFRONT
SYSTEM

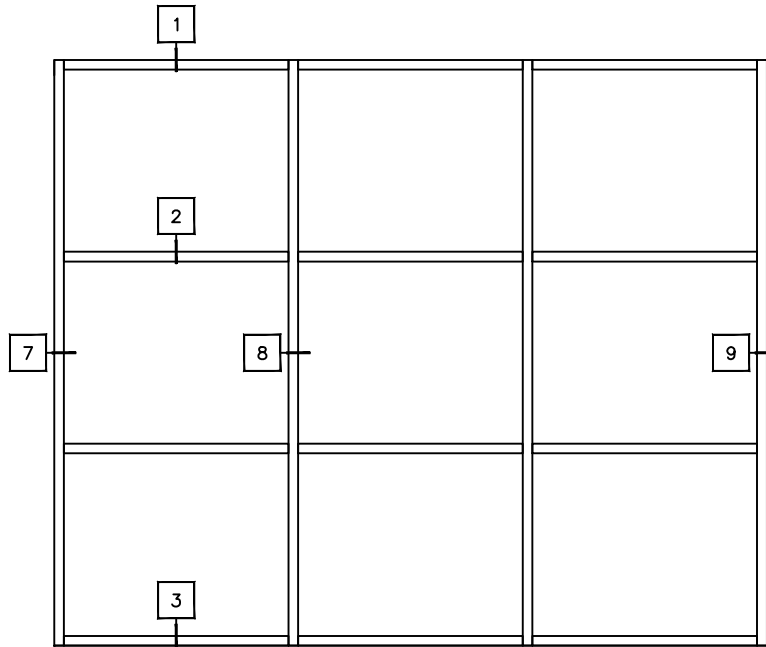
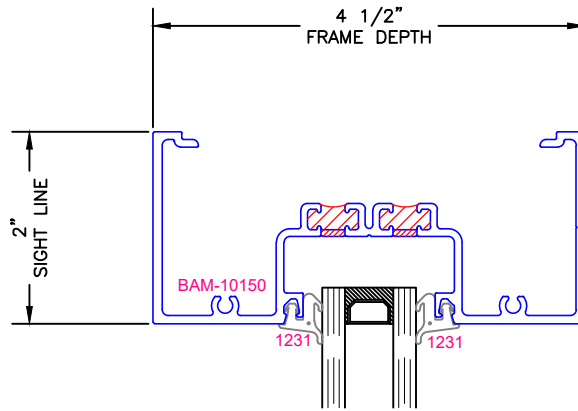

1
HEAD

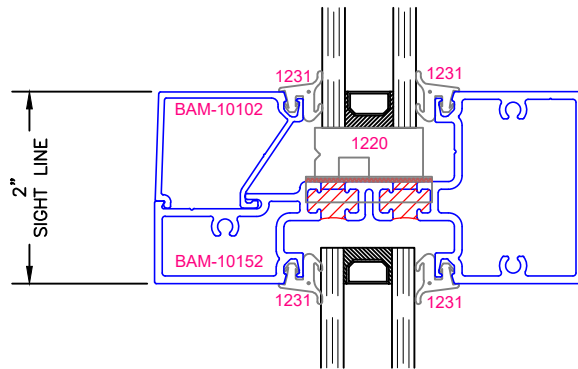

2
HORIZONTAL

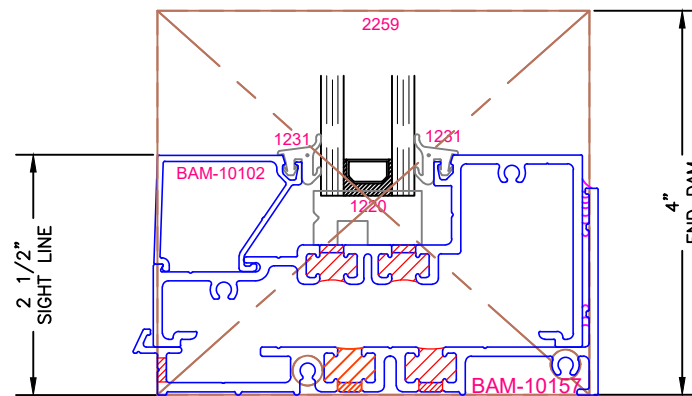

3
SILL

Let's Shine.

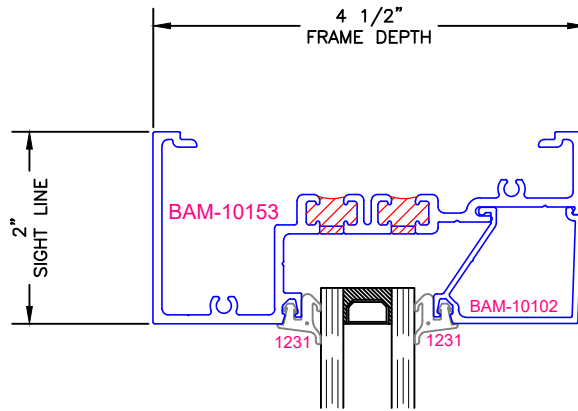

4
HEAD

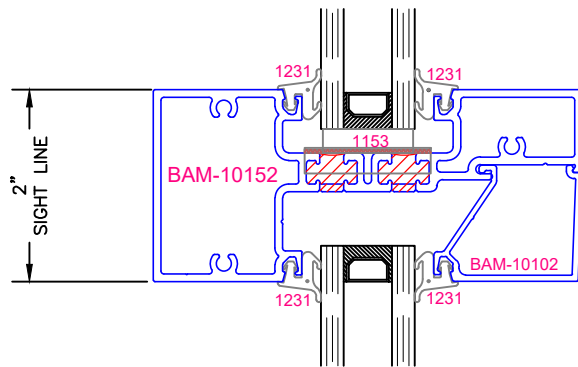

5
HORIZONTAL

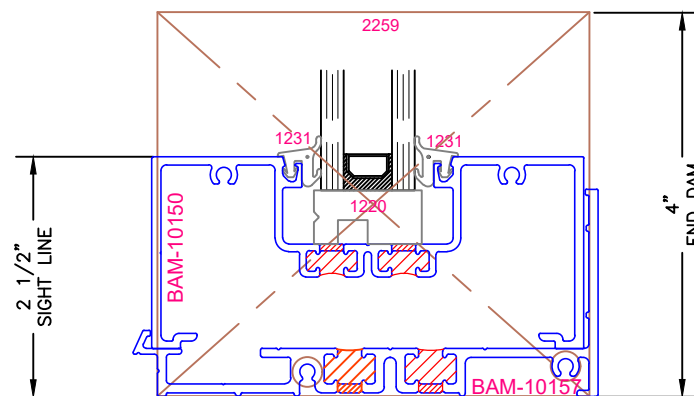

6
SILL

Let's Shine.

7

JAMB

8

VERTICAL

9

JAMB

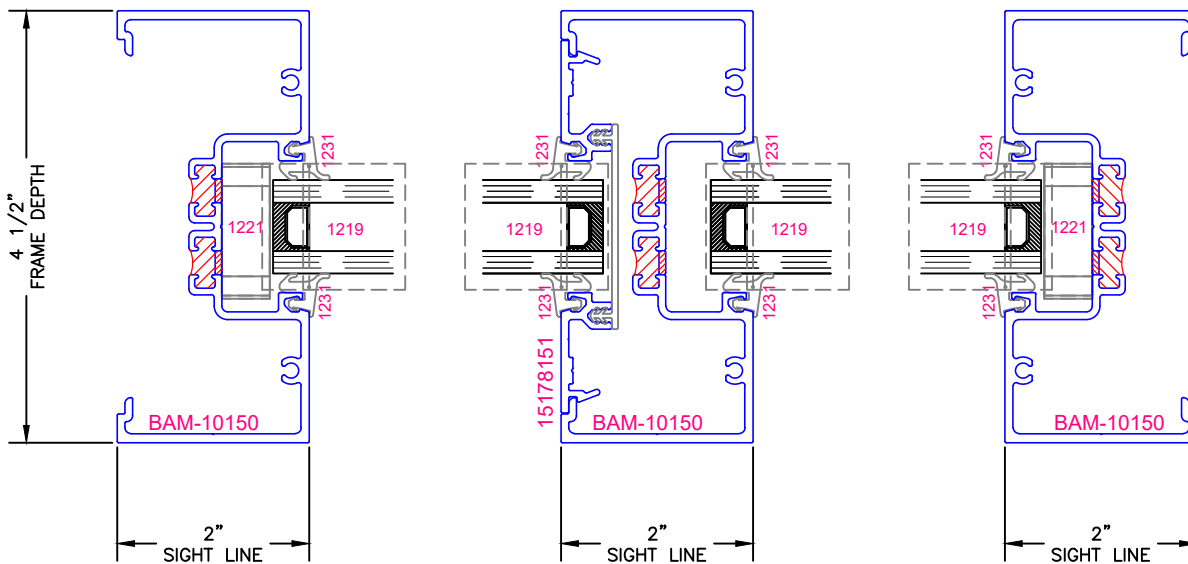

Let's Shine.

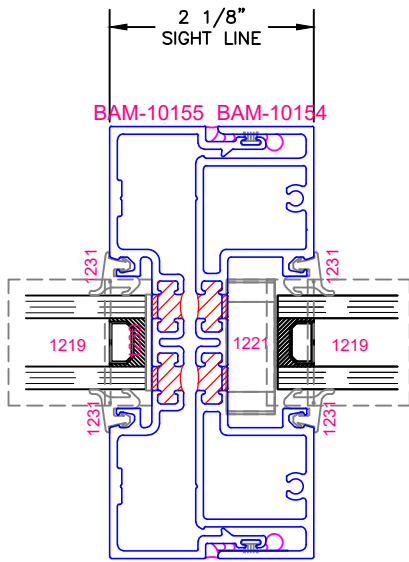

10
EXPANSION MULLION

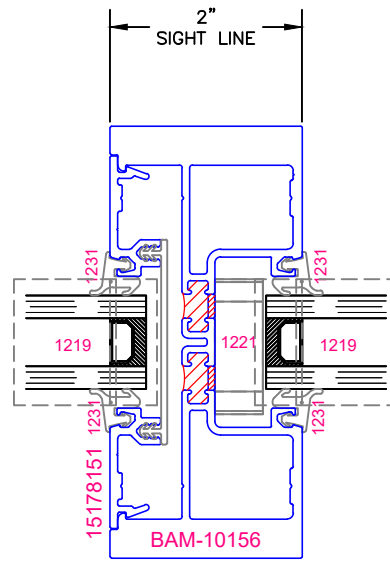

11
HEAVY DUTY MULLION

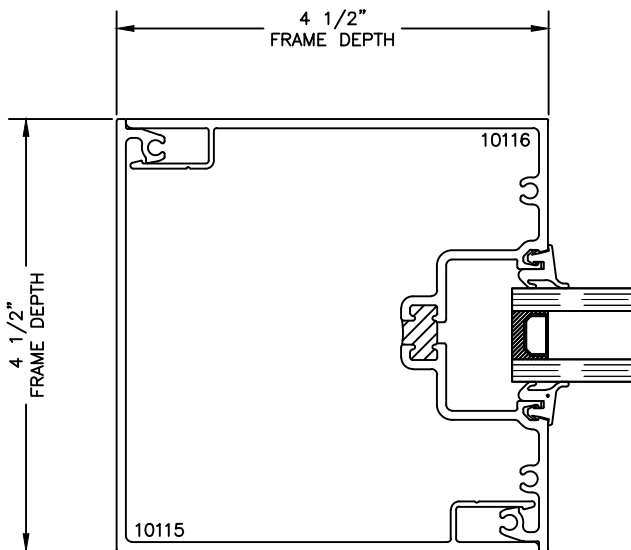

12
4" JAMB

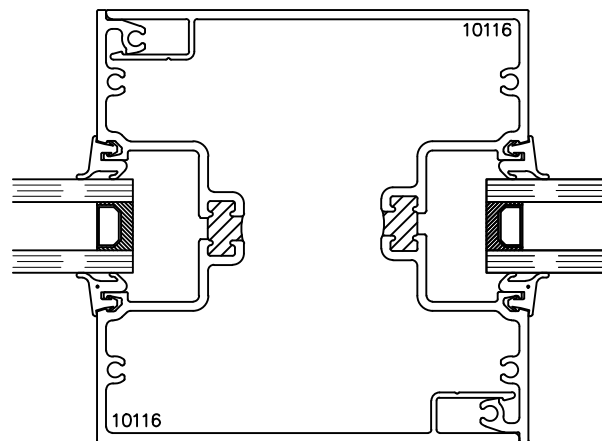

13
4" MULLION

Let's Shine.

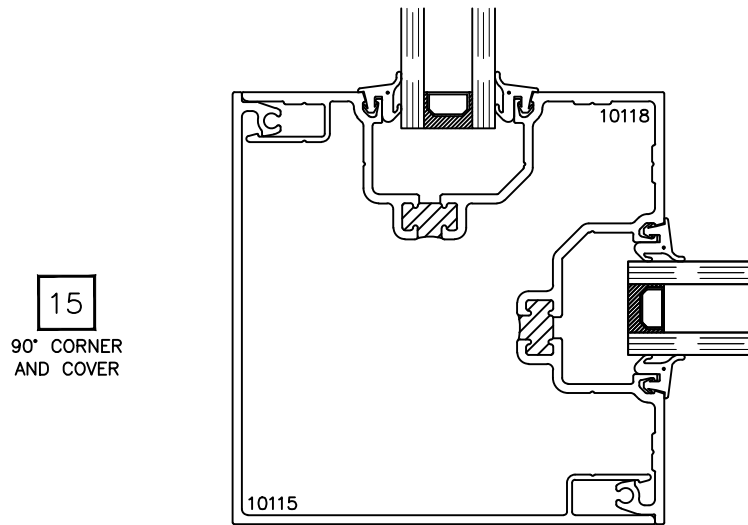
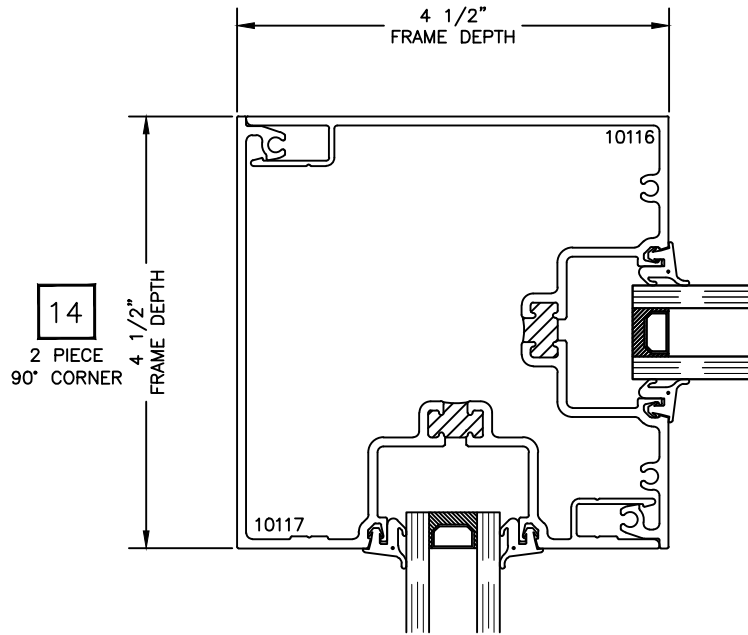

Let's Shine.

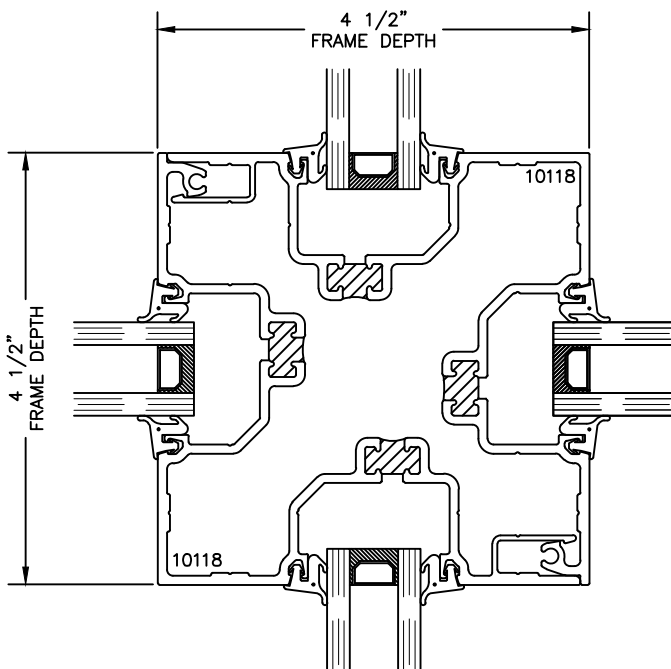

16

4 WAY MULLION

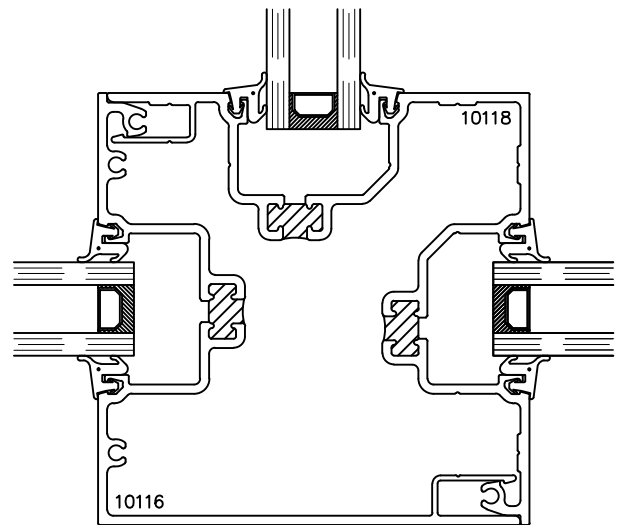

17

3 WAY MULLION

Let's Shine.

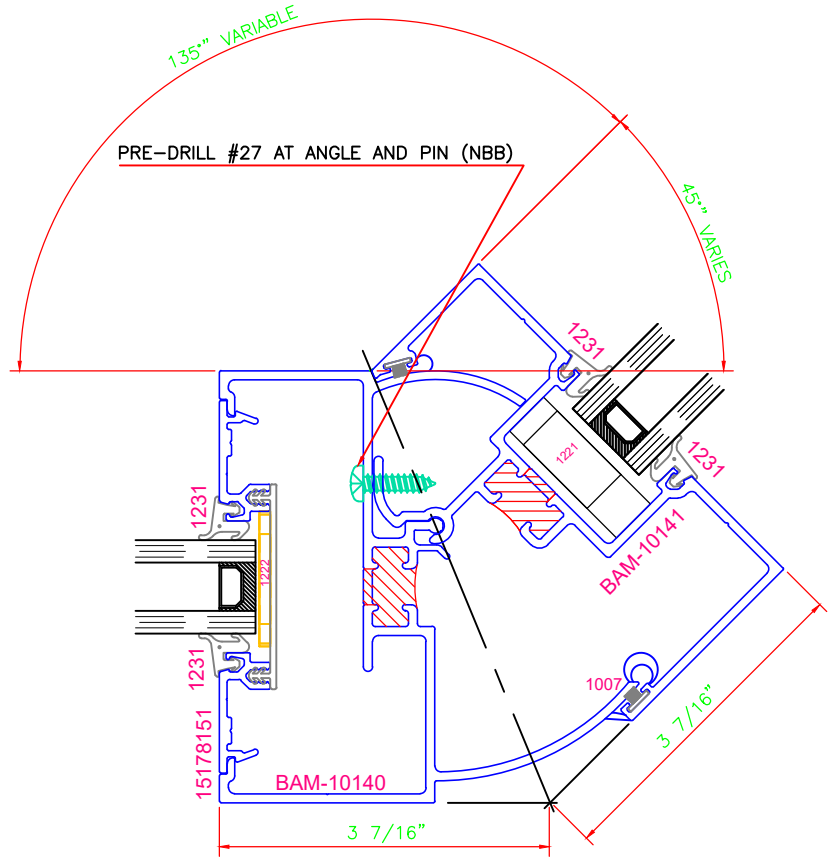
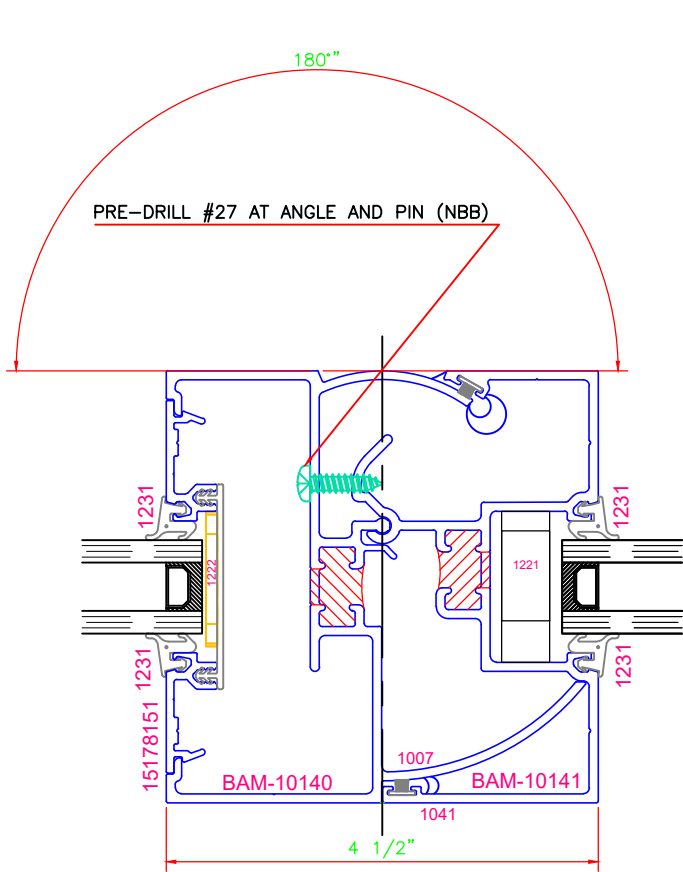

18

VARIABLE DEGREE MULLION

Let's Shine.